

Pool Backwash Tank

260L

Our pool backwash range is supplied with a unique combination of accessories and fittings that enable you to reclaim, store and reuse pool backwash water in order to reduce water use and limit wastage.

Side view

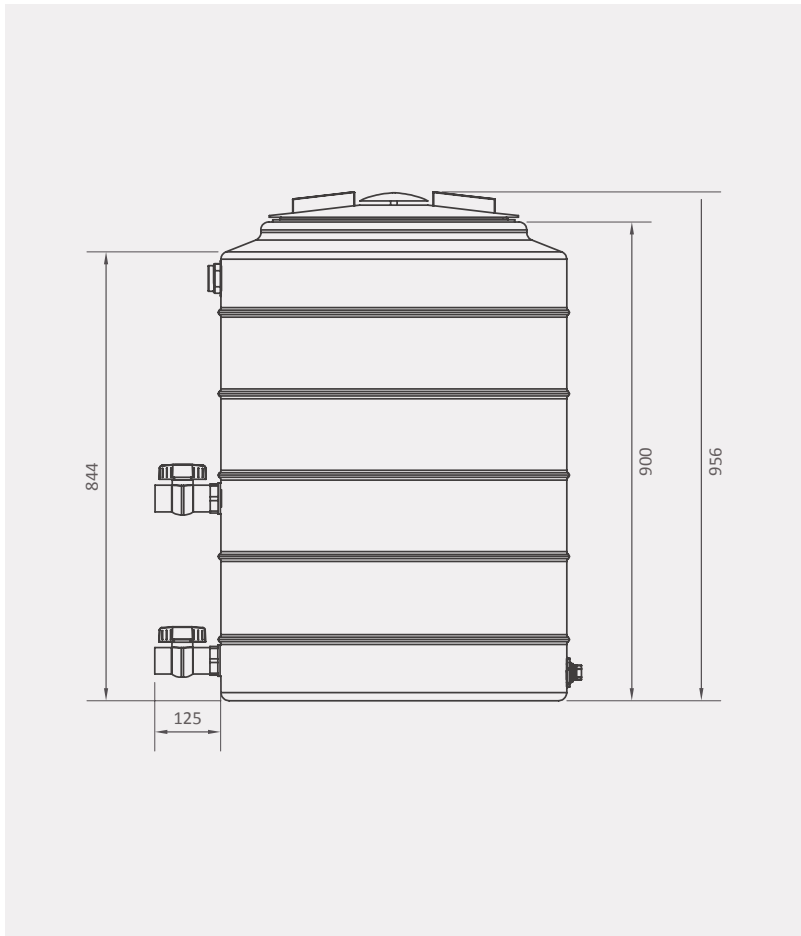

Top view

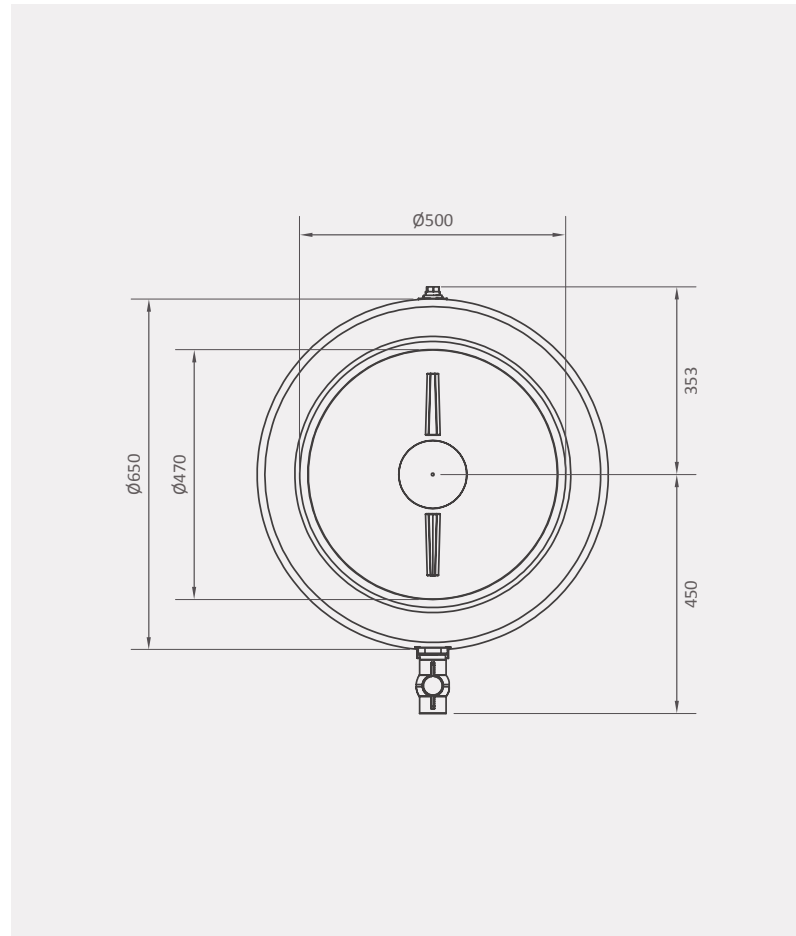

Product specifications:

Application:

- Above ground
- Temporary storage and reuse of pool backwash water
- Domestic use

Supplied with:

- 1) 410mm screw-on lid
- 2) Inlet fitted with:
 - 20mm female water tank fitting
 - 20mm thumb end plug
- 3) Outlet 1 fitted with:
 - 32mm tank connector
 - 32mm ball valve
- 4) Outlet 2 fitted with:
 - 32mm tank connector
 - 32mm ball valve
- 5) Overflow fitted with:
 - 50/40mm reducer
 - 40mm thumb end plug

Availability:

Standard colour

Agreement South Africa certification
10-year guarantee

Dimensions are in millimeters and the drawings are drawn on a scale of 1:15. The design is the property of Calcamite.