

Manhole

2000mm

Designed with ease-of-use and rapid installation in mind, our range of manholes allow for five possible inlet connection points, are lightweight, durable and abrasion-resistant.

Front view

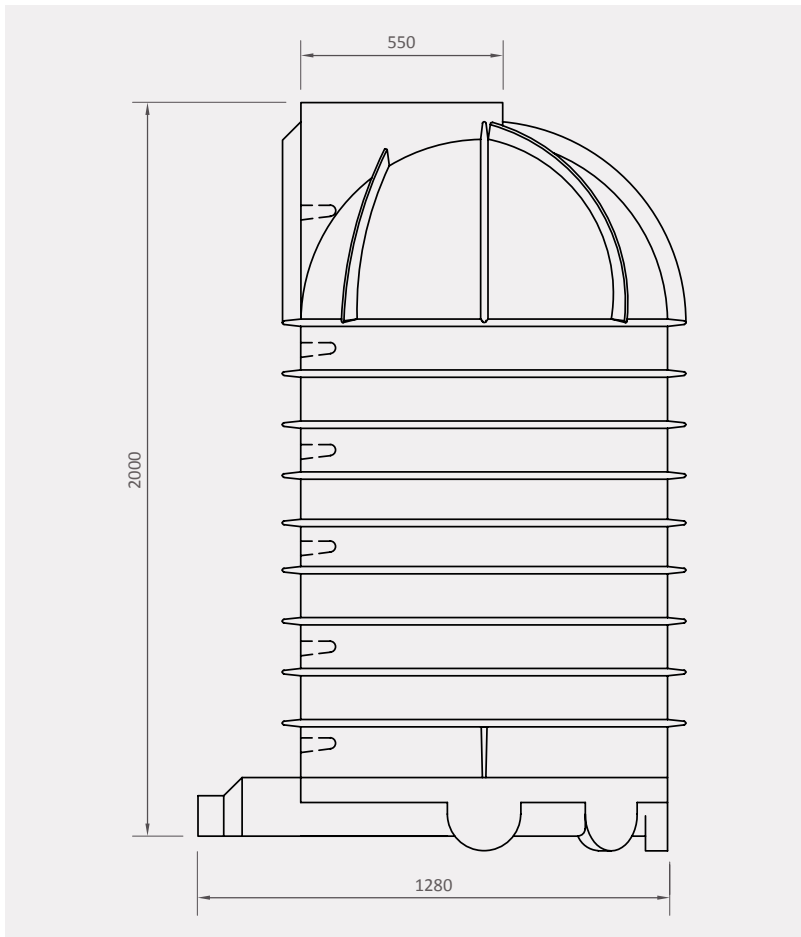

Top view

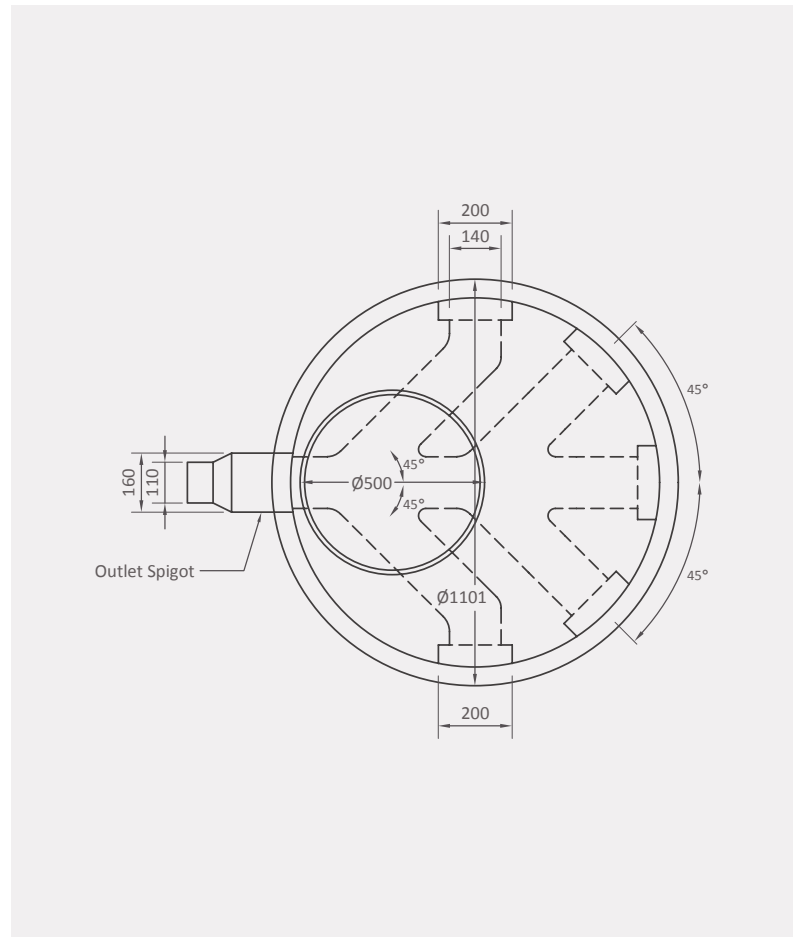

Product specifications:

Application:

- Access point for maintenance of underground sanitation and wastewater systems
- Junction box for cable joining below ground

Supplied with:

- 1) 560mm lid

Connection size options:

- Inlet/s - 110 or 160mm (5 different location options)
- Outlet - 110 or 160mm

Note: if no connections are requested, none will be added.

Optional extras for installation:

Standard 110 or 160mm gaskets for the inlet and outlet connections, and a 560mm (d) by 150mm or 500mm (h) lid extension (depending on height requirements).

Note: these are not included as part of the product offering, but are available on request.

Availability:

Standard colour ●

10-year guarantee

All dimensions are in millimetres and the drawings are drawn on a scale of 1:75. The design is the property of Calcamite.